

LIFESTYLE ENHANCEMENT

STRUCTURES THAT OFFER SOLUTIONS

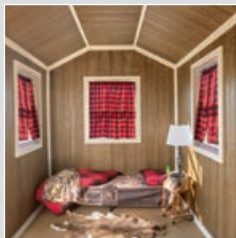
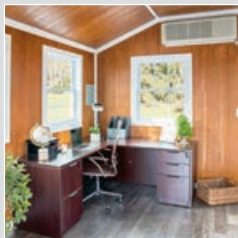

LIFESTYLE
Enhancement

STRUCTURES

Welcome

LIFESTYLE
Enhancement
STRUCTURES



Having the space you need to pursue your lifestyle choice, can make the difference needed to reach your goals and pursue your dreams, and feeling constant frustration by the limitation of space. We want to fill that need for you.

We want to help you with the space you need to pursue your goals!

You have goals, dreams, and a desire to push through the limitations of where you are now in life. Some things, like space to make those aspirations a reality, don't need to stand in your way.

We can build a shed to fit your needs! when you step inside one of our backyard sheds, you don't think shed! it's a cozy space that can be transformed into whatever you need it to be! It is and feels solid, well insulated, and well built, as it should be!

Whether you need a one room space, or a tiny house feel, we got your back. The structures featured in this brochure are just a sampling of what we can do for you.

Give us a call and lets discuss what would work best for you to allow you the space you need to reach your goals.

DON'T LET LACK OF SPACE LIMIT YOU.





Cabin 4-7



Office / Studio 8-11



Mini Cabin 12-13



Garage / Workshops ... 14-17



Home Gym 18-19



Man Cave 20-21



Options / Colors 22-33





Cabin 14' x 32' with 6' Porch

Exterior Standard Features Deluxe Style - Chestnut Brown Siding and White Trim, Weathered Gray Shingles, Three 34x41 Windows, 30" Entry Door, Brown Decking on Porch

Shown with Exterior Options: L-P Siding, 6' Board & Batten on Porch with Cedar Stain, Three 24x36 Windows, Two 34x41 Windows, 9-Lite Pre-Hung Doors, Extra 30" Pre-Hung Door, Black Z Shutters, Wood Railings, 2 Exterior Entrance Lights, Urethane Stain

Interior Standard Features: Clear Stain

Shown with Interior Options: Knotty Pine Interior, Urethane Stain, Rustic Plank Vinyl Flooring, Mini Split, (24,000 BTU) Ceiling Fan w/Light, Electrical Package with Breaker Box, Coffee Stain on 96" Kitchen Cabinets with Sink in Middle, 96" Wall Cabinet, 24x72 Utility Cabinet, Bedroom, Restroom, On Demand Water Heater, White Painted Walls in Restroom, Vanity Cabinet, Toilet, (not installed) Shower

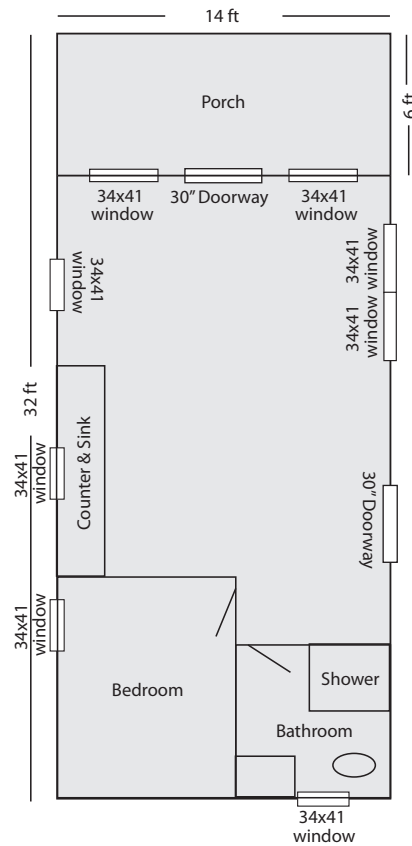

Add a solar panel, and a water source and you can live 'off the grid'! This cabin is a wonderful alternative to pulling a typical mobile home or RV onto your woodland. Need it for an area with uncomfortable temperatures? Upgrade to insulation options to make it comfortable wherever you decide to use it. Make it your cozy get-away and fill it with wonderful memories!



Add custom steps, or a small porch floor to keep the dirt from your shoes at a minimum.



Interested in the log furniture pictured?
 Contact Countryside Rustic Log Furniture.
 717-669-0209

See p... 20-31 for more wall, floor and color options.





Mini House 14' x 32' with 6' Porch

Exterior Standard Features Deluxe Style - Chestnut Brown Siding and White Trim, Green Shingles, Green Shutters, Three 34x41 Windows, 30" Entry door, Brown Decking on Porch

Shown with Exterior Options: L-P Siding, 6' Board & Batten on Porch with Cedar Stain, Three 24x36 Windows, Two 34x41 Windows, 9-Lite Pre-Hung Doors, Extra 30" Pre-Hung Door, Black Z Shutters, Wood Railings, 2 Exterior Entrance Lights, Urethane Stain

Interior Standard Features: Clear Stain

Shown with Interior Options: Knotty Pine Interior, Urethane Stain, Rustic Plank Vinyl Flooring, Mini Split, (24,000 BTU) Ceiling Fan w/Light, Electrical Package with Breaker Box, Coffee Stain on 96" Kitchen Cabinets with Sink in Middle, 96" Wall Cabinet, 24x72 Utility Cabinet, Bedroom, Restroom, On Demand Water Heater, White Painted Walls in Restroom, Vanity Cabinet, Toilet, (not installed) Shower

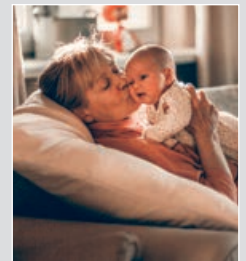
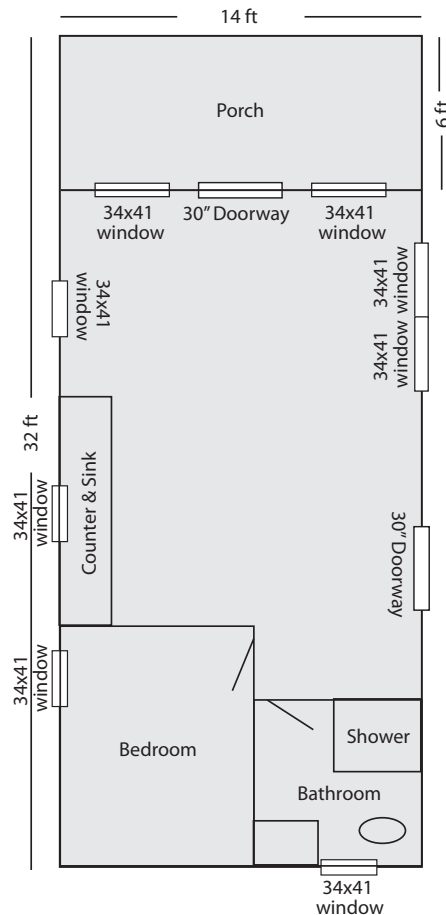

This mini house has so many uses! In-Laws visiting? Give them their own space and make everyone more comfortable. Teens keeping you awake? Give them a space where they can be loud - late. Order yours to be the space you need to simplify and improve your life!







Office / Studio

12' x 18' with 6' Porch

Exterior Standard Features: Traditional Style - with Pearl Vinyl Siding and Bronze Trim, Weathered Gray Shingles, Three 34x41 Windows, 30" Entry Door

Shown with Exterior Options: 6' Porch, Two 24x36 Windows, 2 Additional 34x41 Windows, 4-Lite Pre-Hung Door, 15-Lite Pre-Hung Door, Black Raised Panel Shutters, Aluminum Railings

Shown with Interior Standards: L-P Siding, White Trim

Shown with Interior Options: Redwood Urethane Stain, Colonial Plank Vinyl Flooring, Heat/AC Unit (15,000 BTU) One Additional Light, Exterior Entrance Light, Electrical Package with Breaker Box, 3 Additional Receptacles

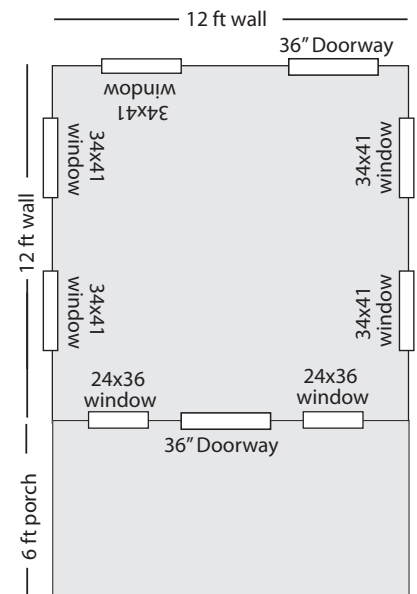

DON'T LET LACK OF SPACE LIMIT YOUR CONCENTRATION.

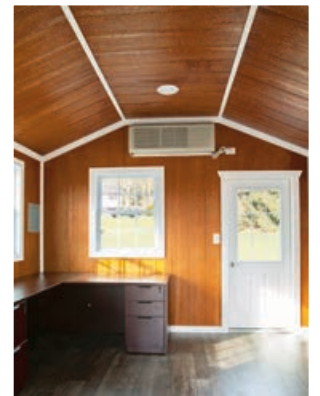

This space is light and airy with windows all around! Perfect for a studio, arts/crafts room, play room, or office. Make it yours - order it with the custom options you need.



See p... 20-31 for more wall, floor and color options.





Carriage Style Office 10' x 12'

Exterior Standard Features: Deluxe Style - with Navajo Siding and Red Trim, Williamsburg Slate Shingles, Three 34x41 Windows, 30" Entry Door

Shown with Exterior Options: Duratemp Siding, 4-Lite Pre-Hung Door, 1 Additional 34x41 Windows, 2 Additional 24x36 Window

Shown with Interior Standards: L-P Siding, Navajo Trim

Shown with Interior Options: Butternut Urethane Stain, Colonial Plank Vinyl Flooring, One Additional Light, Electrical Package with Breaker Box, 3 Additional Receptacles

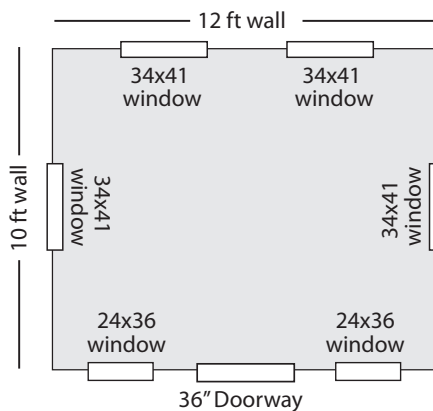

Live in a warm climate area? Have us build your structure with double doors, so you can open up both doors and allow the inspiration of nature into your space. Want the light, but not the elements? We can do double doors with 15-lite windows.

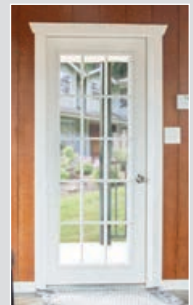

Go green with your space by adding a solar panel!



DON'T LET LACK OF SPACE LIMIT YOUR INCOME.



Having a built in shelf/desk, you can save a significant amount of space. Typical desk size is quite deep, and the depth is often not as needed as the width. A built in shelf/desk allows you to choose the depth and save space.



Add custom steps, or a small porch floor to keep the dirt from your shoes at a minimum.

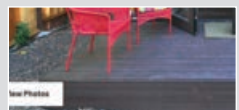

See p... 20-31 for more wall, floor and color options.





Mini Cabin 8' x 16'

Exterior Standard Features: Traditional Style - Mushroom Stain, Two 34x41 Window, 30" Entry Door

Shown with Exterior Options: 3 Additional 34x41 Windows, Pre-Hung Door, Green Metal Roof, Board/Batten Siding

Shown with Interior Standards: L-P Siding, Navajo Trim

Shown with Interior Options: Chestnut Brown Urethane

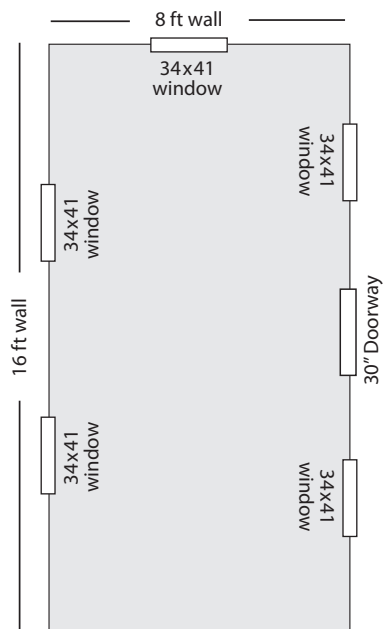

The perfect structure to set in the woods to live in during hunting season! Or, the perfect place to retreat to whenever you need time to reenergize and relax alone. Many options can make the space even better! Add a loft to sleep in and save the floor space for a comfy sofa or recliner. Add a solar panel for even more added comforts.

See p... 20-31 for more wall, floor and color options.



DON'T LET
LACK OF
SPACE LIMIT
YOUR
'ME TIME'.





Garage / Workshop 14' x 36'

Exterior Standard Features: Traditional Style - with Avocado Siding and Navajo Trim, Weathered Gray Shingles, Three 34x41 Windows, 36" Entry Door, Standard Comes with Painted Interior (not shown)

Shown with Exterior Options: L-P Siding, 4'x14' Loft, 9'x7' Overhead Door, PTF

Shown with Interior Standards: L-P Siding

Shown with Interior Options: 2'x10' Workbench, Electrical Package with Breaker Box

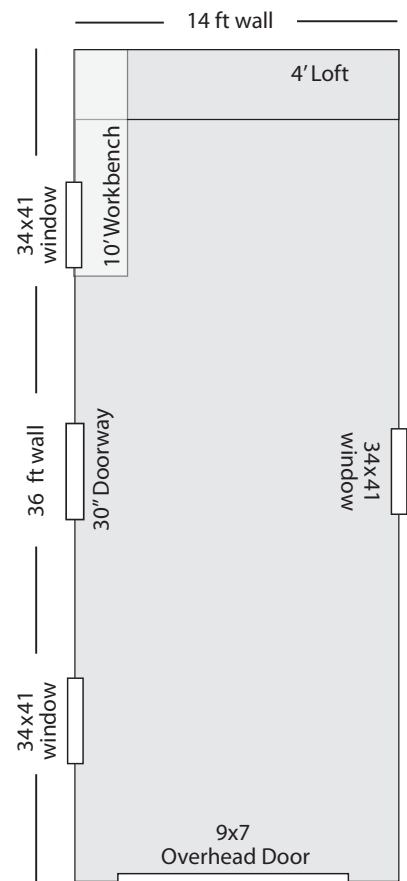



This spacious garage provides an amazing amount of space, not only for two vehicles, but also with plenty of space on each side to make accessing the car, getting groceries out of the trunk, fully opening the doors to help the kids with carseats, etc, you never need to feel restricted by the space around you! Add a workbench for tools, or for a small potting shed area. The optional loft also adds some always needed storage space, out of the way, but easily accessible.

DON'T LET
LACK OF SPACE
LIMIT YOUR
FUN.



See p... 20-31 for more wall, floor and color options.



Workshop 12' x 20'

Traditional Style - Dk Gray Siding and White Trim.
Three 34x41 Windows, 30" Entry Door

Shown with Exterior Options: L-P Siding, Black Metal Roof,
3 Additional 34x41 Windows, 4-Lite Door

Shown with Interior Standards: Navajo L-P Siding, White Trim

Shown with Interior Options: 2'x10' Workbench w/Epoxy,
2 Additional Lights, Electrical Package with Breaker Box,
3 Additional Receptacles

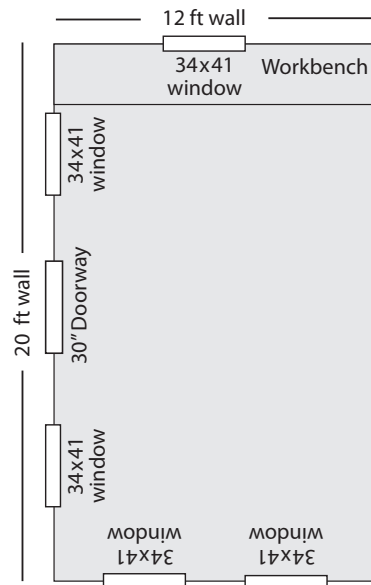

For maximized organization space, consider pegboard for one whole wall. This allows you to use your whole wall for hanging baskets, shelves, and all your supplies easily without needing to put excessive holes in your new walls. TIP: consider using the wall where your door is, so that the room feels bigger, emptier and less cluttered when you step inside.



DON'T LET LACK OF SPACE LIMIT YOUR CREATIVITY.



Epoxy Workshop Surface Keeps Your Work Space Easy To Clean.

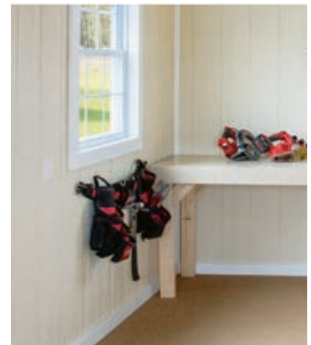

See p... 20-31 for more wall, floor and color options.





Home Gym 12' x 20'

Traditional Style - Red Siding and White Trim, Three 34x41, Windows, 30" Entry Door

Shown with Exterior Options: L-P Siding, Black Metal Roof, Stone Front, 2 Additional 34x41 Windows, 4-Lite Door

Shown with Interior Standards: Navajo L-P Siding, White Trim

Shown with Interior Options: 2'x10' Workbench w/Epoxy, 2 Additional Lights, Electrical Package with Breaker Box, 3 Additional Receptacles, Rubber Matting

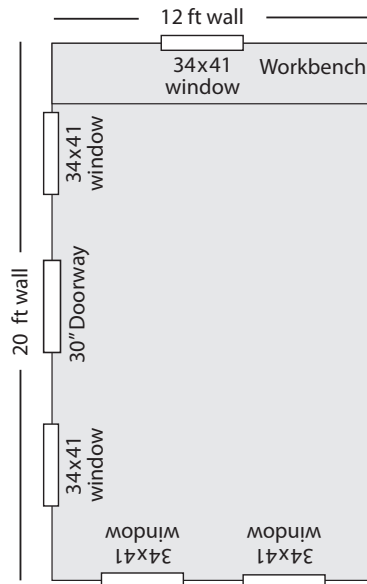

The indoor pictures shown have rubber matting installed. This is an option that makes working out easier and more comfortable. This is not an option we offer to install, but many easy to install options are available online.

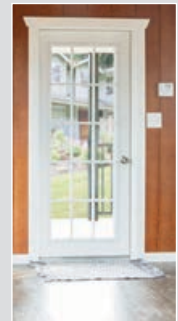

DON'T LET LACK OF SPACE LIMIT YOUR WORKOUT.

If you like the idea of having a light airy space to workout in, you may want to add a 15 light door - this adds a lot of light!



We can install rubber matting to make your space more comfortable

Epoxy Surface Keeps Your Work Space Easy To Clean.



See p... 20-31 for more wall, floor and color options.





Man Cave 12' x 16'

Deluxe Style - Redwood L-P Siding and Buckskin Trim, Three 34x41 Windows, 30" Entry Door, Charcoal Shingles

Shown with Exterior Options: L-P Siding with Redwood Urethane Stain, 1 Additional 34x41 Window, 9 Lite Pre-Hung Door, One Additional 15 Lite Pre-Hung Door, Black Z Shutters

Shown with Interior Standards: Navajo L-P Siding, Navajo Trim

Shown with Interior Options: 64" Cabinet with Sink, Electrical Package with Breaker Box, 1 Additional Light, 3 Additional Receptacles, Colonial Plank Vinyl Flooring, Heat/AC Unit 15,000 BTU

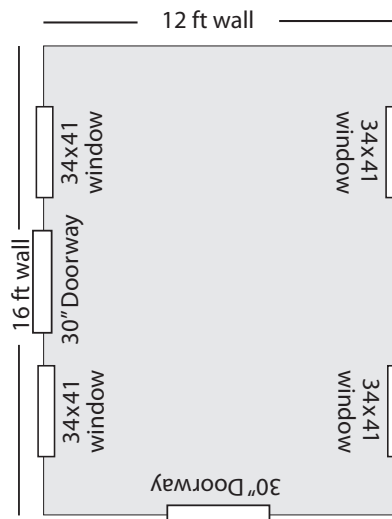

Consider the amount of windows you want - for the activity you will be using the room for. If you will be using it mostly for screen time, you may want to limit your windows and put more focus on sound proofing with extra insulation in the walls and floor.

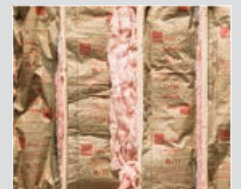

R-13 Batten Insulation For Walls & Ceiling

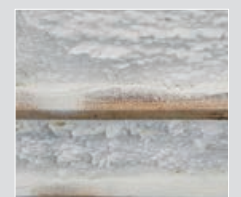

R-14 Closed Cell Spray Foam under Floor



DON'T LET LACK OF SPACE LIMIT YOUR RECHARGE TIME.



See p... 20-31 for more wall, floor and color options.



Wall & Flooring Options

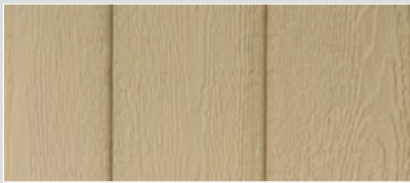

Interior L-P Siding- Painted



Interior L-P Siding- Stained



Knotty Pine (available in clear stain only)

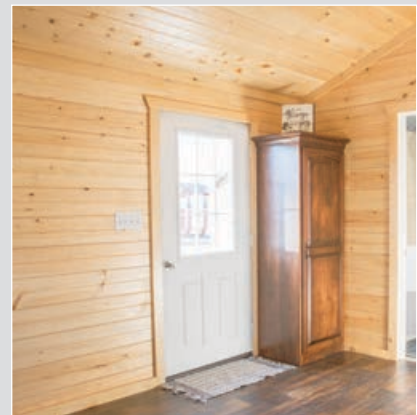

PVC Trusscore Lined - Durable for wash down Interior

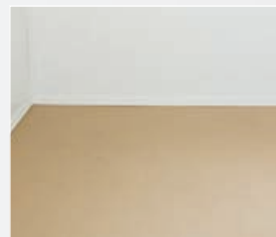

Poly Urea Flooring
Totally watertight & durable for wash down

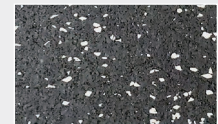

Gym Floor Matting
Interlocking 24" Tiles,
8mm Thick Available In
Solid Black,
Black/Blue,
Black/White.

Vinyl Flooring



Rustic Plank



Colonial Plank



Playtime

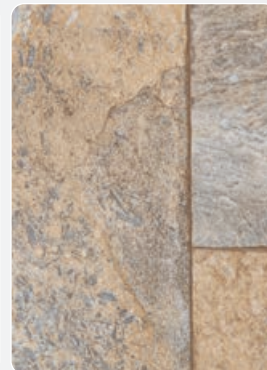

Grand Canyon



Savor

Lighting Options



Ceiling Fan/Light



Exterior Flood Lights Double Bulb



Antler Chandelier



Sink Light



Exterior Entrance Lights



Loft



R-13 Batten Insulation
In Walls & Ceiling

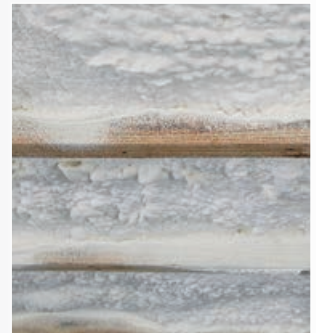

R-14 Closed Cell Spray
Foam under Floor

Work Bench Options



Workbench w/Epoxy



Detail of workshop w/Epoxy



Standard Workbench

Heating & Cooling Options

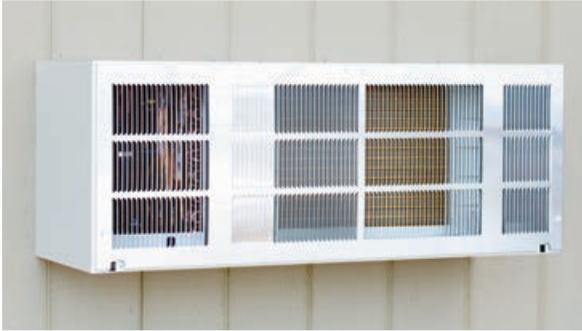

Exterior View



A/C Unit Installed



Mini Split Heater/AC Unit
• Available in 12000 BTU or 24,000 BTU
12,000 BTU Requires 110 Volt A-C
24,000 BTU Requires 220 Volt A-C



Interior View of
Mini Split Heater/AC Unit



LP Cozy Direct Vent Wall Furnace
Blower Kit Also Available
14,000 or 33,000 BTU



LP Procom Wall Mount
Thermostat Heater



Interior View
A/C Unit Installed

Electrical Options



Solar System (Installed)
Sized According to Your Needs



Electrical Package
Includes:

- 1 Light
- 1 Receptacle
- 1 Light Switch
- Electrical Box
- More Lights and Receptacles Can be Added



12 Volt Light Package
Includes: • 1 Light • 1 Light Switch
• More Lights Can be Added

Hot Water Heater Options



30 Gallon L-P
Hot Water Heater



Electric Marey Tankless
Water Heater
240 - V 60 AMP Circuit
Domestic Water Supply Only



Marey Tankless
Water Heater L-P Gas
Domestic Water Supply
Only



Navien On Demand
Water Heater
Uses LP and Electric
Domestic Water Supply
or Floor Heat Applications



Electric 15 Gallon
Water Heater
110-V 20 AMP Circuit

Cabinet and Sink Area Options



64" Cabinet w/sink



96" Cabinet w/sink in middle, 96" Wall cabinet



32" Cabinet w/ 3 Drawers



32" Cabinet w/ 1 Drawers, 2 Doors



30" Wall Cabinet



36" Arch Bottom Shelf



Double Sink



Standard Faucet



Utility Cabinet



Bunk Beds



Faux Wood Blinds

Cabinet Stain Colors



Natural



Provincial

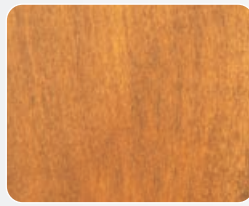

S-12



Cocoa



Cappuccino



Coffee



Smoke



Acres

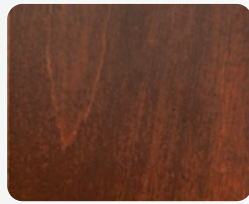

Rich Cherry



Onyx

Counter Top Colors

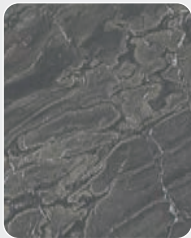

Portoro

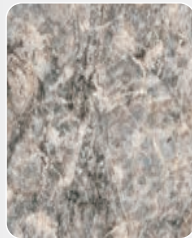

Cafe De Presco



Benjamin Gray

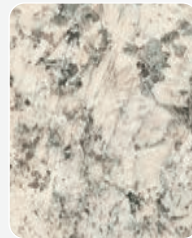

Typhoon Ice

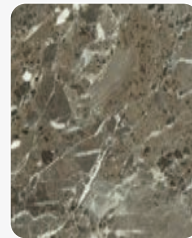

Breccia

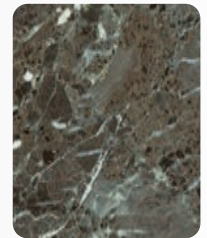

Breccia Nouvelle

Bathroom Options



Toilet - Uninstalled



Shower



Vanity Cabinet - Installed

Windows & Doors



Slab Door



Pre-Hung Door



9-Lite Door



Slab Door Latch



Pre-Hung Door Knob



11-Lite Door



Vent-Lite Door



15-Lite Door



Wooden Z Shutters

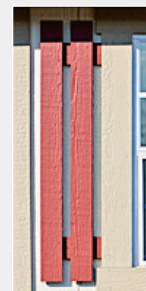

Slat Shutters

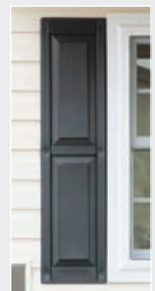

Raised Panel Vinyl Shutters



24x36 Window



34x41 Window



36x36 Sliding Window w/screen



20" x 40" Double Pane Sliding Window w/screen

Exterior Examples



L-P Siding with stain



L-P Siding Painted



Board n Batten Siding with stain



Vinyl Siding



Duratemp Siding Painted



Metal Siding & Roofing

Cupolas & Weather-Vanes



Board & Batten Wood w/ Copper Top



Shed Cupola, White



Black Eagle



Black Horse



Small Black Rooster



Copper Standing Rooster



Copper Eagle



Copper Horse

Railing Options



Aluminum Railing and Post



Wood Railing and Post



Vinyl Railing and Post

Metal Roofing & Siding



Shingle Colors

Cedar Shake (Optional)



Deluxe Trim Package



Elite Trim Package



Traditional Trim Package



Vinyl Colors



Paint Colors

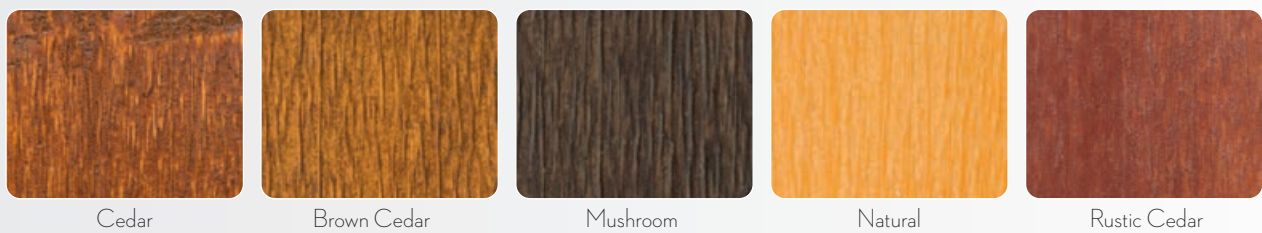

Exterior Stain Colors

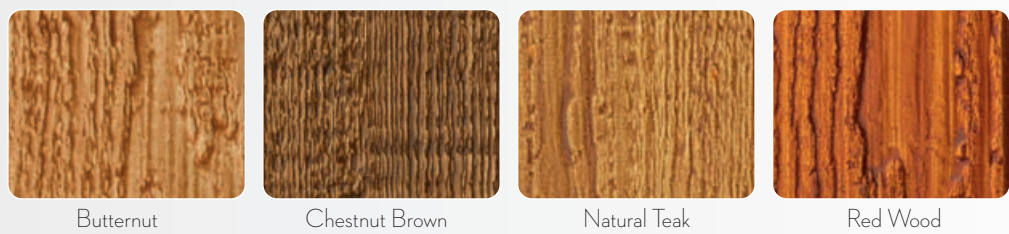

Urethane Stain Colors

LIFESTYLE
Enhancement
STRUCTURES



DON'T LET LACK OF SPACE
LIMIT YOUR LIFESTYLE.

Authorized Dealer

Bird-in-Hand
STRUCTURES™